

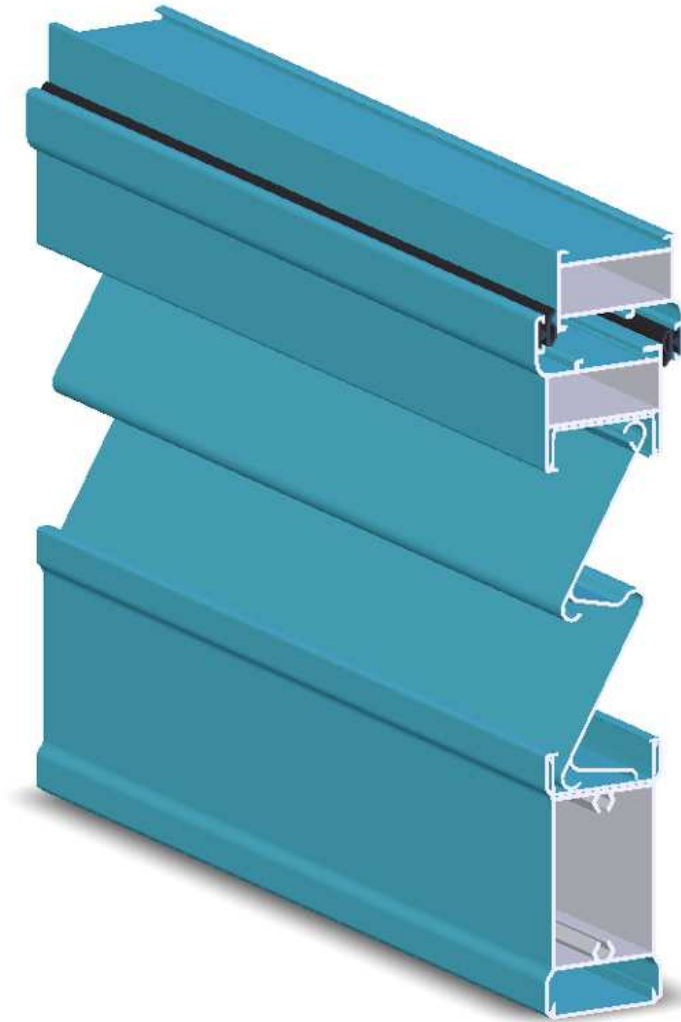

alesil
ALUMÍNIOS



SÉRIE ALESIL



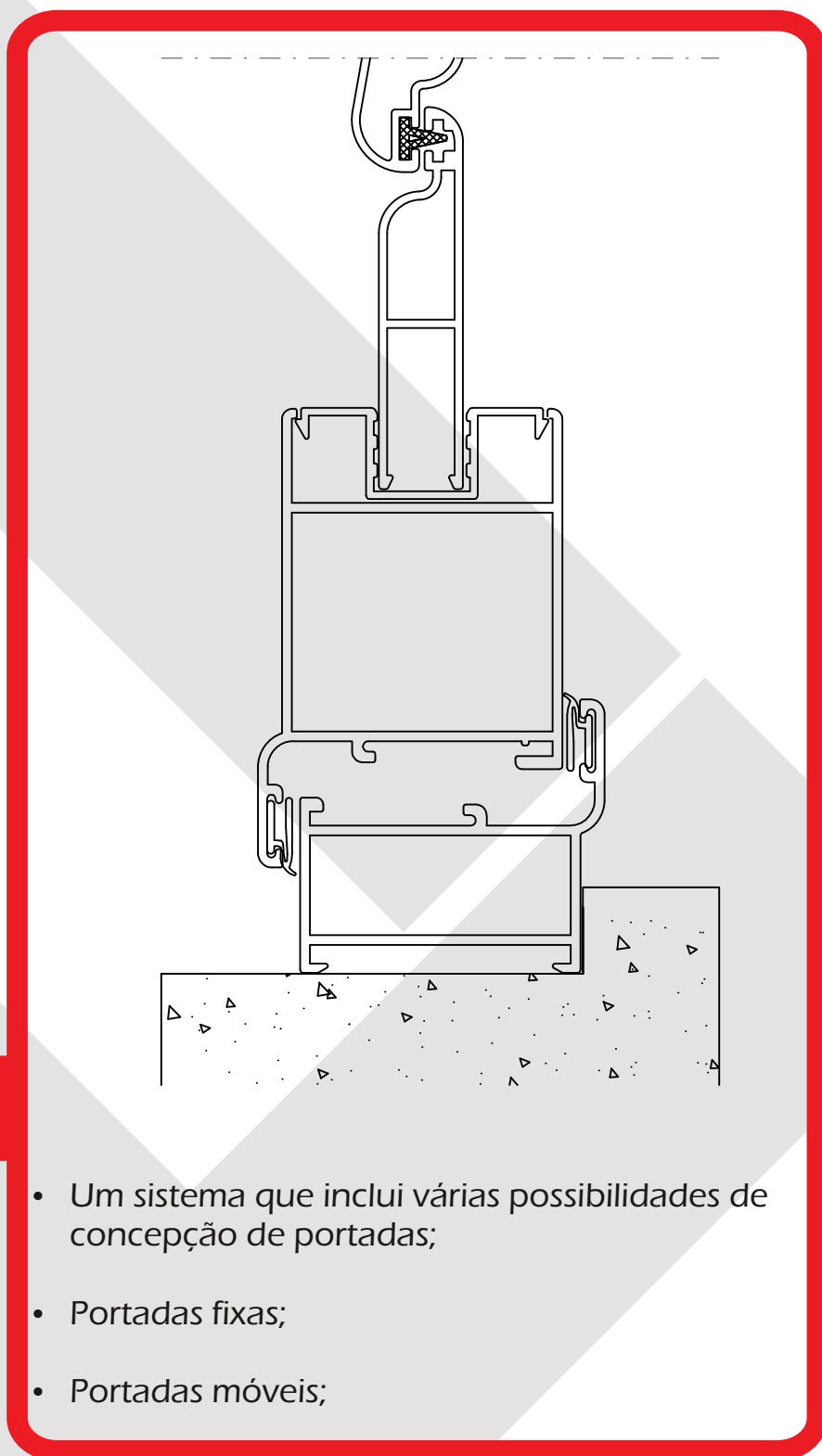
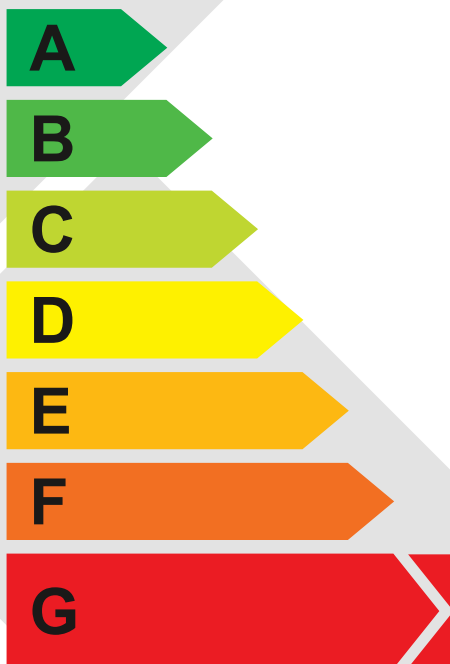

PORTADAS ALESIL

ALESIL 941

Aro Fixo

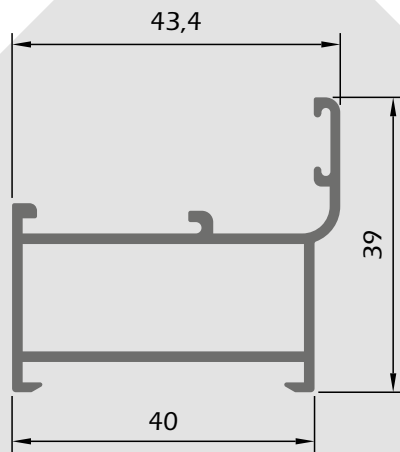

ALESIL 946

Aro Fixo com Remate

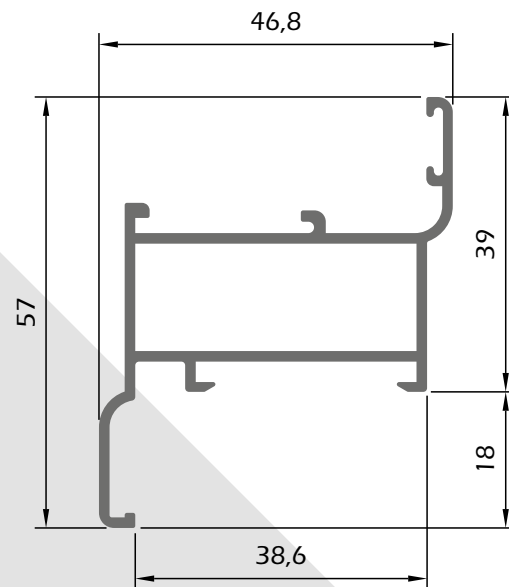

ALESIL 944

Aro Fixo Móvel

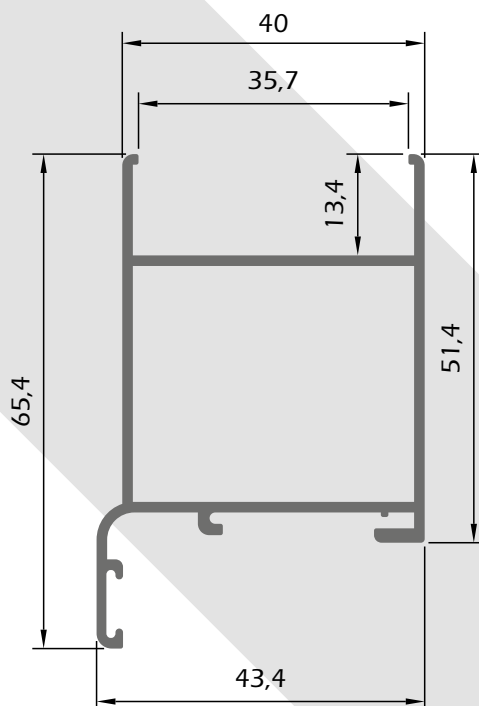

ALESIL 942

Aro Fixo Móvel

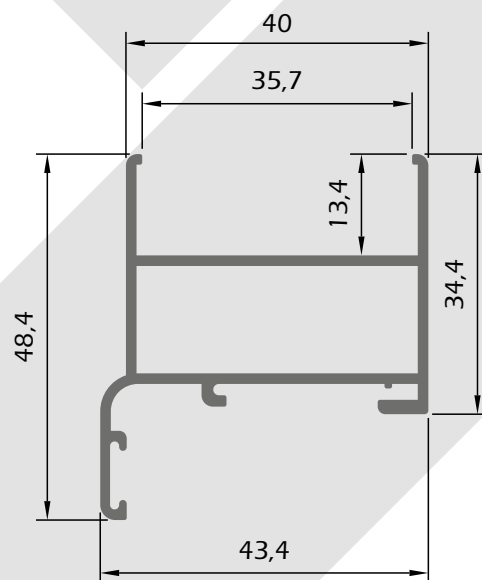

PORTADAS ALESIL

ALESIL 943

Almofada

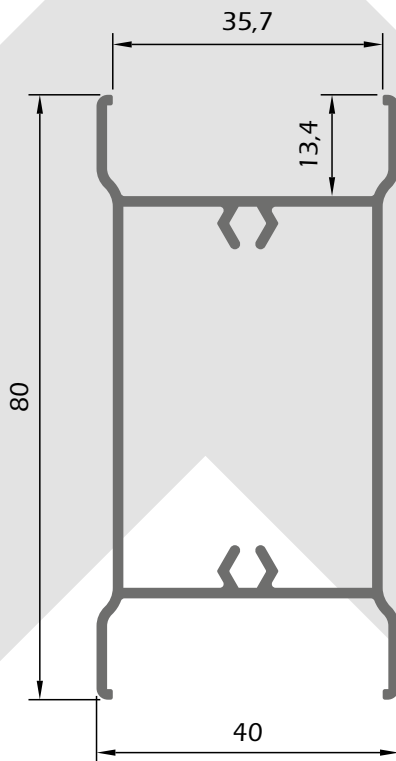

ALESIL 950

Tampa Terminal Z-52

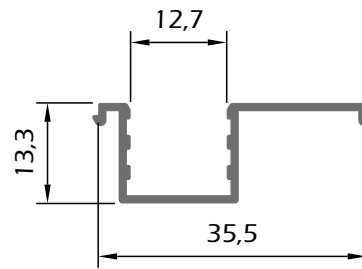

ALESIL 950-A

Tampa Terminal Z-52-T

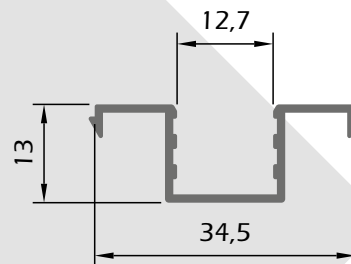

ALESIL 945

Tampa Terminal W-25 e W-25-B

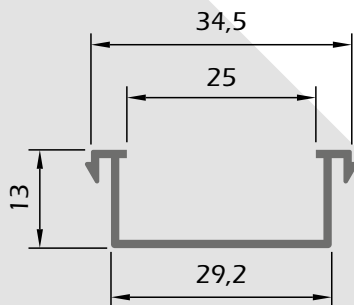

ALESIL 951

Tampa Terminal Z-34-A

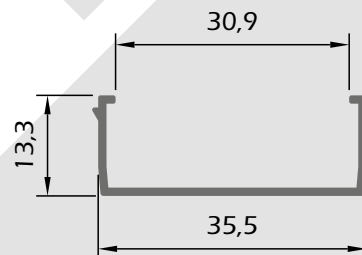

ALESIL 952

Tampa

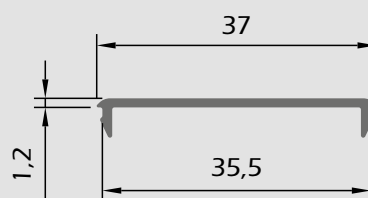

PORTADAS ALESIL

Z-35

Lâmina Oval



Z-47

Lâmina Oval

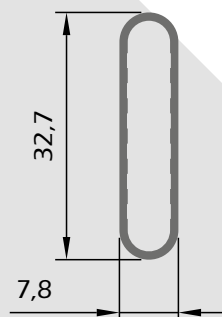

Z-40

Lâmina Trapezoidal

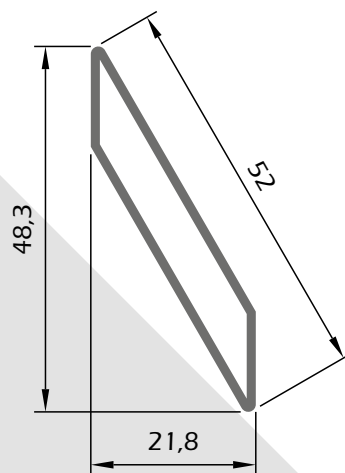

Z-37

Lâmina em S

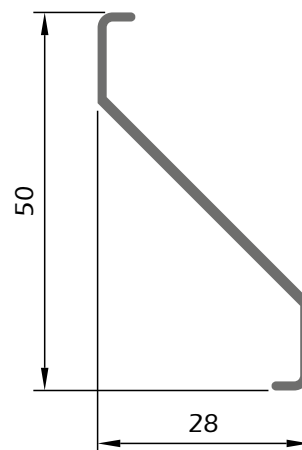

Z-34

Lâmina Fixa Dupla em Z

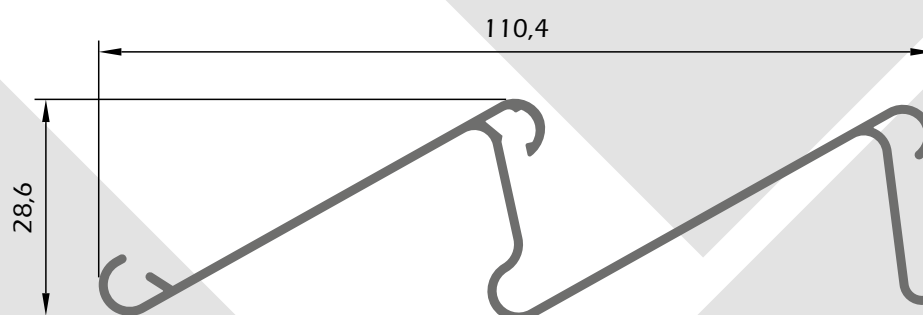

Z-34-A

Lâmina Fixa Tripla em Z

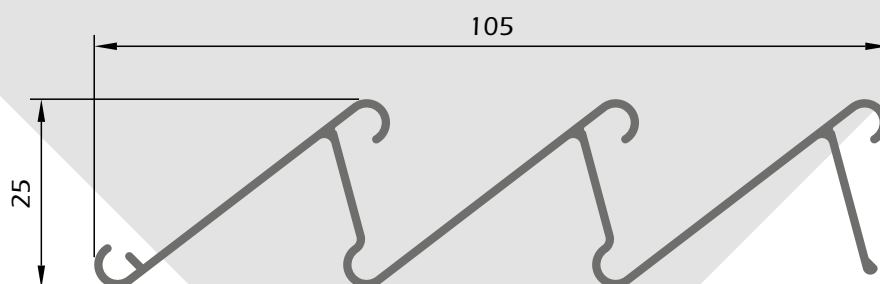

PORTADAS ALESIL

W-25-B

Chapa Dupla Lisa

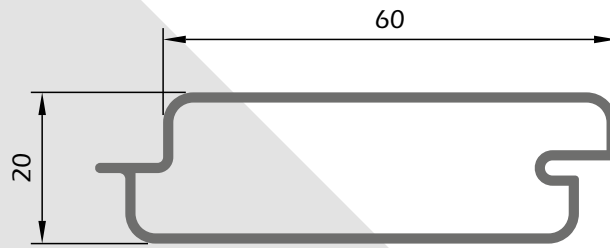

W-26-A

Chapa Dupla com Friso

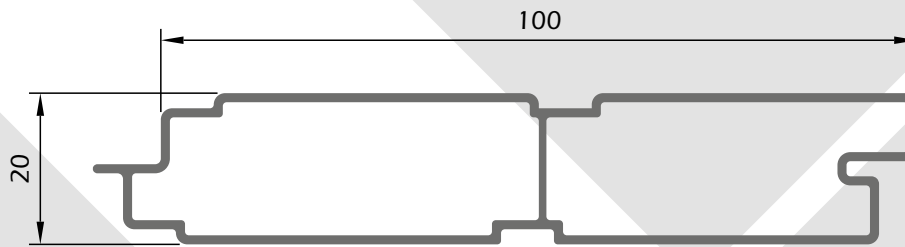

W-25

Chapa Dupla Lisa

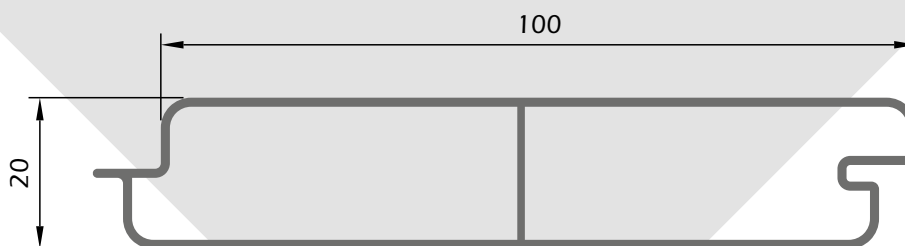

PORTADAS ALESIL

P40-18

Lâmina Orientável

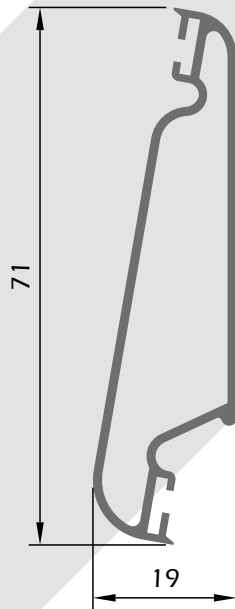

Z-52-A

Lâmina Orientável

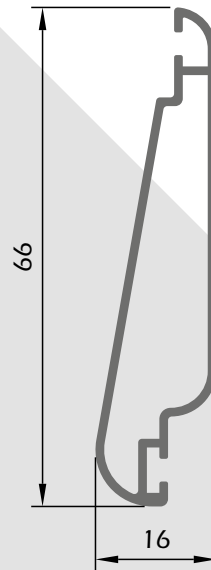

Z-52

Lâmina Orientável

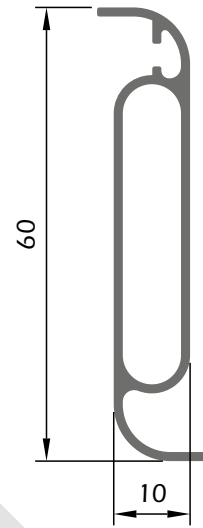

P40-16

Remate Lâmina P40-18

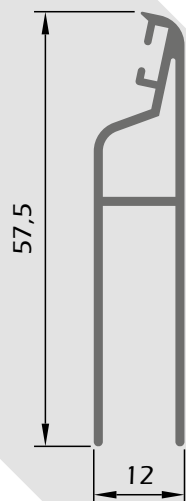

Z-52-T

Remate Lâmina Z-52-A

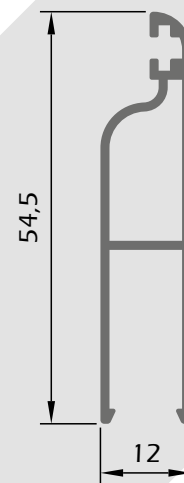

PORTADAS ALESIL

ACESSÓRIOS

Características

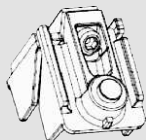

CÓDIGO: **MONT.406** DESCRIÇÃO: **Esquadro monticelli**
UNID. VENDA: **Unidade** ACABAMENTOS: **Zamak**
APLICAÇÃO: **AF-03, AF-14, AF-20A**

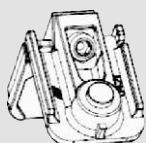

CÓDIGO: **MONT.421** DESCRIÇÃO: **Esquadro monticelli**
UNID. VENDA: **Unidade** ACABAMENTOS: **Zamak**
APLICAÇÃO: **AF-01, AF-02, AF-04**

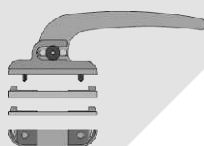

CÓDIGO: **CRE.4940** DESCRIÇÃO: **Trinqueta reversível**
UNID. VENDA: **Unidade** ACABAMENTOS: **Alumínio e zamak injectado**
APLICAÇÃO:



CÓDIGO: **BX.IRIA** DESCRIÇÃO: **Cremone Iria**
UNID. VENDA: **Unidade** ACABAMENTOS: **Alumínio e zamak injectado**
APLICAÇÃO:



CÓDIGO: **FEC. 136/134** DESCRIÇÃO: **Fecho 2ª Folha**
UNID. VENDA: **Unidade** ACABAMENTOS: **P V C**
APLICAÇÃO:



CÓDIGO: **VD AF BR** DESCRIÇÃO: **Vedante Batente**
UNID. VENDA: **Rolo** ACABAMENTOS: **Nitrilico**
APLICAÇÃO:





CÓDIGO: **VD Z 52BR** DESCRIÇÃO: **Vedante P/ Z-52 Base Rigida**
UNID. VENDA: **Rolo** ACABAMENTOS: **Nitrilico**
APLICAÇÃO: **Z-52**





















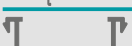





CÓDIGO: **VDZ52-ABR** DESCRIÇÃO: **Vedante Lamina Z-52-A B.Rigida**
UNID. VENDA: **Rolo** ACABAMENTOS: **Nitrilico**
APLICAÇÃO: **Z-52-A**

PORTADAS ALESIL

TABELA LÂMINAS

	N.º Lâminas	Maxi 54	Maxi 55	Maxi 60	
1 Comando	5	371	378	400	
	6	425	434	460	
	7	479	490	520	
	8	533	546	580	
	9	587	602	640	
	10	641	658	700	
	11	695	714	760	
	12	749	770	820	
	13	803	826	880	
	14	857	882	940	
	15	911	938	1000	
	16	965	994	1060	
	17	1019	1050	1120	
	18	1073	1106	1180	
	19	1127	1162	1240	
	20	1181	1218	1300	
	2 Comandos	21	1235	1274	1360
		22	1289	1330	1420
		23	1343	1386	1480
		24	1397	1442	1540
25		1451	1498	1600	
26		1505	1554	1660	
27		1559	1610	1720	
28		1613	1666	1780	
29		1667	1722	1840	
30		1721	1778	1900	
31		1775	1834	1960	
32		1829	1890	2020	
33		1883	1946	2080	
34		1937	2002	2140	
35		1991	2058	2200	
36		2045	2114	2260	
37		2099	2170	2320	
38		2153	2226	2380	
39		2207	2282	2440	
40		2261	2338	2500	
LÂMINAS					

PORTADAS ALESIL

Imagem	Referência	$I_{xg} (cm^4)$	$I_{yg} (cm^4)$	Imagem	Referência	$I_{xg} (cm^4)$	$I_{yg} (cm^4)$
	ALESIL 941	2,11	5,38		W-25	2,21	34,41
	ALESIL 942	3,02	6,46		W-25-B	1,45	10,51
	ALESIL 943	20,56	8,15		W-26-A	2,17	35,35
	ALESIL 944	9,12	8,26		Z-34	1,79	26,96
	ALESIL 945	0,17	1,16		Z-34-A	1,32	22,38
	ALESIL 946	4,00	7,10		Z-35	2,40	0,15
	ALESIL 950	0,19	0,84		Z-37	1,81	0,90
	ALESIL 950-A	0,17	0,77		Z-40	2,32	0,64
	ALESIL 951	0,13	1,30		Z-47	0,76	0,07
	ALESIL 952	0,01	0,74		Z-52	5,60	0,26
	P40-16	4,20	0,36		Z-52-A	6,90	0,44
	P40-18	9,75	0,77		Z-52-T	3,71	0,34

Todos os dados fornecidos são determinados relativamente ao centro de gravidade do perfil e conforme posição apresentada, em relação aos eixos indicados

